

General specifications	
Spa weight (dry)	452 Kg
Spa weight (filled)	1712 Kg
Package dimension	1200x2420x2510mm
Package weight	520 Kg

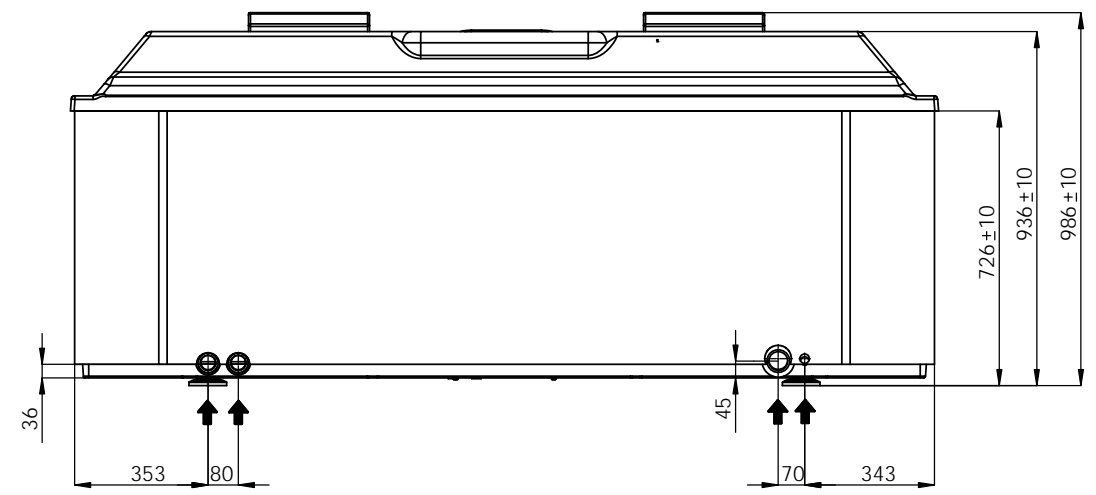

ELECTRICAL BOARD CONNECTIONS ACCESS

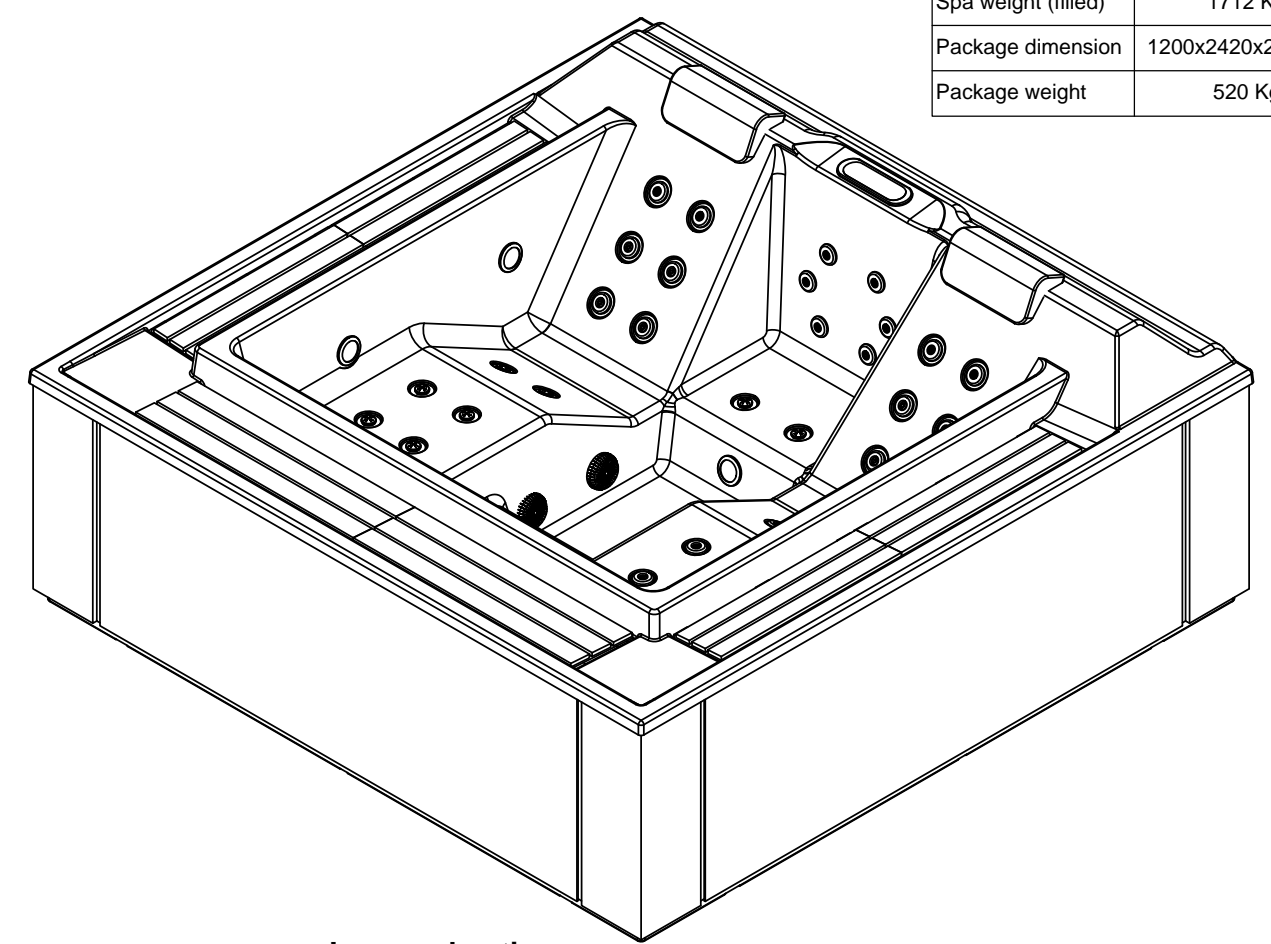
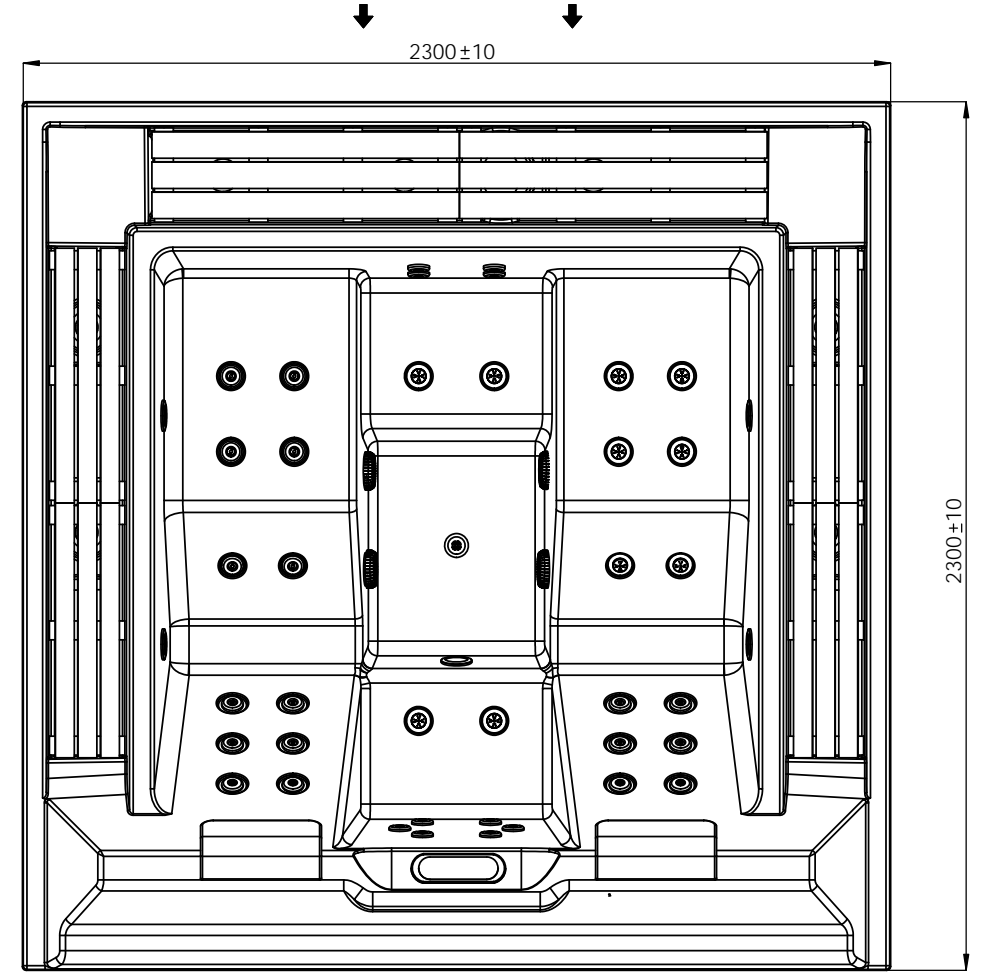

**Inground option**

**WARNING:**  
It's essential to keep a minimum clearance access of **700mm** all around.  
Minimum depth of spa hole **730 mm**.

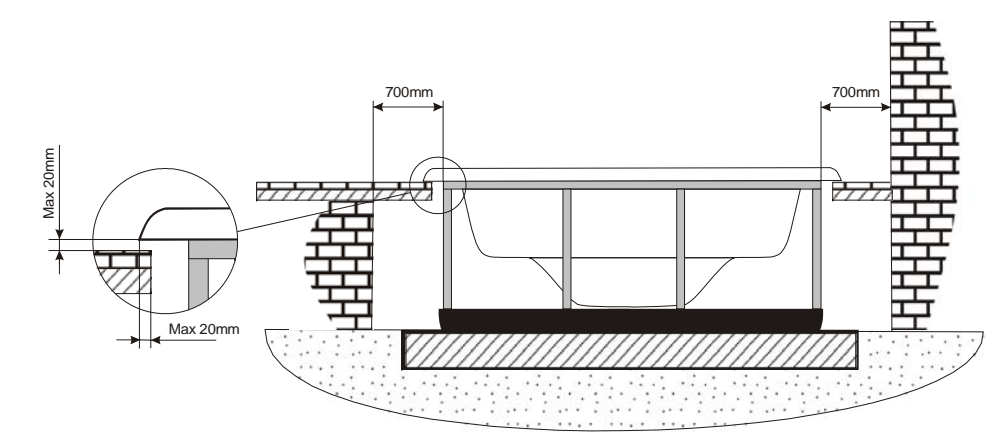

According to our policy of continuous improvement, dimensions, features or components of this product can be partially or completely changed without prior notice.  
It's Customer responsibility to verify that this is the last version of the drawing

Change No.	Date	Name	Modification
04	07/10/2014	I.Pozo	Change Blower 700W, add Detail A and new spare templates
03	29/07/2013	X.Codina	Add Jets and new position
02	15/11/2012	X.Codina	New Cabinet
01	25/04/2012	I.Nicolas	Drawing Release

Remarks Dimensions in mm. General Tolerances +/- 10mm			<b>COMMERCIAL</b>		
Drawn	15/11/2012	X.Codina		Part Number <b>52222</b>	Rev. <b>04</b>
Checked		I.Nicolas			
Scale	1:20	General Tolerance DIN 7168 ISO 2768g			
Sheet	1/2				

Property of IBERSPA S.L. Avda. Pla d'Urgell 2-8 25200 Cervera, Spain. Don't use without permission. Keep this information confidential and use it solely for the permitted purpose.

ACCESSORIES

Position Num.	Part Nº SPARE	Description SPARE	Quant.
2	RPOR0225	GREY SPA DRAIN 2" ADAPTOR SOCKET D.50	4
4	REMP0046	WHITE-STAINLESS STEEL AIR NOZZLE	10
5.1	REMP0055	PRESSURE NOZZLE 63 (GASKET 2 UNITS)	7
8	RPOR0003	GREY DRAIN SET - BODY+COVER+ASSEMBLY	1
10	RPOR0239	SPOTLIGHT LED SET RD	5
10.1	RPOR0240	MASTER LED LIGHT	1
10.2	RPOR0252	LED SLAVE LIGHT	4
15	RPOR0235	JET BODY SET RD 2"	28
16	RPOR0230	FRONTAL JET 2" STAINLESS STEEL DIRECTIONAL	12
17	RPOR0260	JET TWIN ROTO 2" INOX	16
22	RPOR0119	PRESSURE FILTER 2"	1
25	RPOR0195	DIGITAL PANEL VL700+COVER 1 PUMP + BLOWER	1
25.1	RPOR0201	COVER DIGITAL PANEL VL700 1 PUMP + BLOWER	1
32	RPOR0215	BLACK HEADREST BARCELONA SPA	2
36	RPOR0120	PRESSURE FILTER CARTRIDGE	1
40	RPOR0271	FRONT GRATING BCN SPA	2
41	RPOR0272	SIDE GRATING BCN SPA	4

PUMPS SPARE CODES

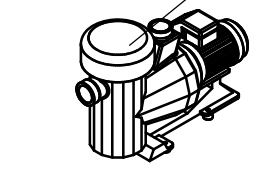
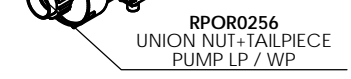

HEATER AND DESINFECTION SPARE CODES

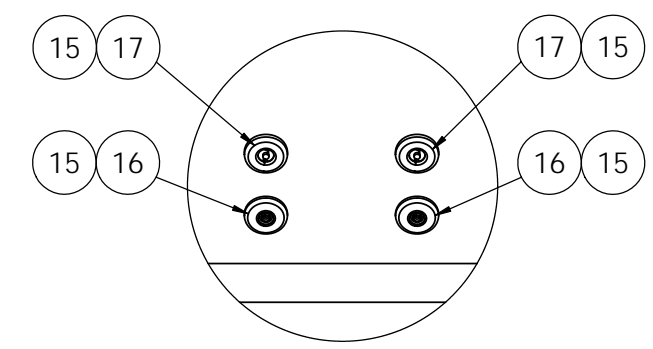
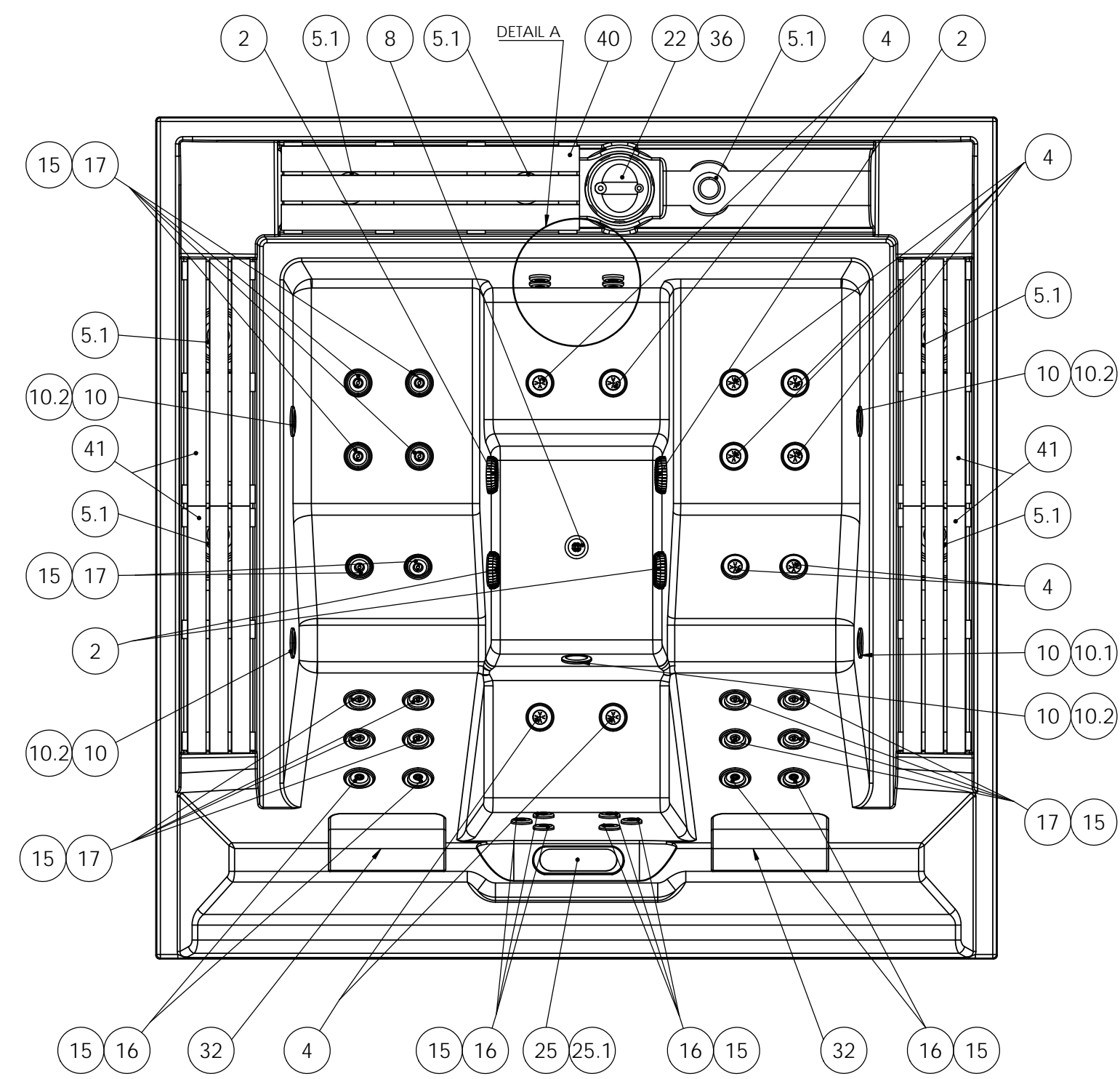

According to our policy of continuous improvement, dimensions, features or components of this product can be partially or completely changed without prior notice. It's Customer responsibility to verify that this is the last version of the drawing

Change No.	Date	Name	Modification
04	07/10/2014	I.Pozo	Change Blower 700W, add Detail A and new spare templates
03	29/07/2013	X.Codina	Add Jets and new position
02	15/11/2012	X.Codina	New Cabinet
01	25/04/2012	I.Nicolas	Drawing Release

Remarks Dimensions in mm. General Tolerances +/- 10mm			SPARE PARTS DRAWING		
Drawn	15/11/2012	X.Codina			
Checked		I.Nicolas	IBERSPA	52222	04
Scale	1:15	General Tolerance			
Sheet	2/2	DIN 7168 ISO 2768g			